

PRODUCT : **LCD MODULE**
MODEL NO : **YTS500RLBA-01-200N**
SUPPLIER : **Yes Optoelectronics Co.,Ltd**
DATE : **Apr.26.2020**

SPECIFICATION

Prepared by	Checked	Approved
LIANGYUEYAO	ANHUI	XIAOYU

CUSTOMER:
MODEL NO.:

DATE:

Approved	Checked	Department

ADD: No.288Yueling Road Anshan, Liaoning, CHINA
TEL: 86-412-5211859 FAX: 86-412-5211729 P.C.:114045
E-mail : yes@yes-lcd.com, yeslcd@globalsources.com
Web: <http://www.yes-lcd.com>
<http://www.asiansources.com/sante.com>

CONTENTS

1.General Specifications	4
2.Mechanical Drawing.....	5
3.PIN Assignment	6
4.Absolute Maximum Rating.....	7
5.Electrical Characteristics.....	7
5.1.Recommended Operating Condition	7
5.2.Recommended Driving Condition for Backlight.....	7
6. Timing Characteristics	8
6.1.AC Electrical Characteristics	8
6.2. DC Electrical Characteristics	9
6.3. Timing.....	10
6.4.Power ON/OFF Sequence.....	11
7.Optical Characteristics	13
8.Environmental/Reliability Test.....	16
9.Packing Drawing.....	17
10. Standard Specifications For Product Quality.....	18
11.Precautions for Use of LCD Modules.....	22
12.Prior Consult Matter.....	26
13.Factory.....	26

Revision Record

Rev No.	Rev Date	Contents	Remarks
1.0	2020.04.24	New creation	
1.1	2020.04.26	Modify mechanical drawing and add typ luminance value.	P5,P13

1. General Specifications

No	Item	Contents	Unit
1	Size	5.0	inch
2	Resolution	800RGB*480	
3	Interface	RGB	
4	Color Depth	16.7	M
6	Pixel Pitch	0.135*0.135	mm
7	Pixel Arrangement	RGB Vertical Stripe	
8	Display Mode	Transmissive, IPS,NB	
10	Viewing Direction	Free	
11	LCM (W x H x D)	120.7*75.8*3.25	mm
12	Active Area (W x H)	108.0*64.8	mm
13	With/Without TSP	Without TSP	
14	LED Numbers	18	

2. Mechanical Drawing

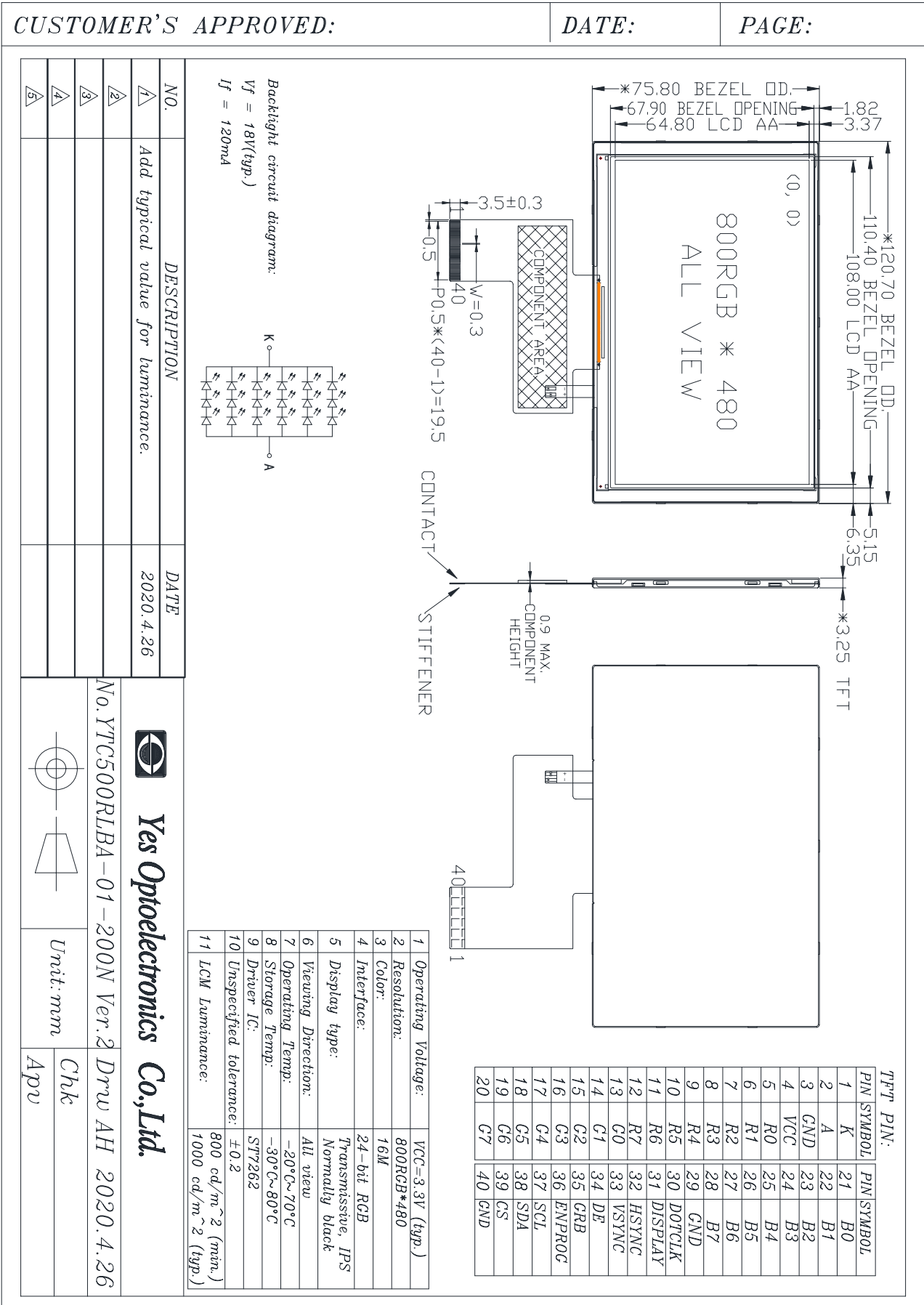

3. PIN Assignment

Pin No	Symbol	I/O	Function	Remark										
1	K	P	LED backlight cathode											
2	A	P	LED backlight anode											
3	GND	P	Ground											
4	VCC	P	Logic regulator power supply											
5-12	R0-R7	I	RGB interface and LVDS interface data input pins. <table border="1"> <thead> <tr> <th>MCU Type</th> <th colspan="2">Function Description</th> </tr> </thead> <tbody> <tr> <td rowspan="3">RGB interface</td> <td>DR[7:0]</td> <td>8 bit data bus display red data.</td> </tr> <tr> <td>DG[7:0]</td> <td>8 bit data bus display green data.</td> </tr> <tr> <td>DB[7:0]</td> <td>8 bit data bus display blue data.</td> </tr> </tbody> </table>	MCU Type	Function Description		RGB interface	DR[7:0]	8 bit data bus display red data.	DG[7:0]	8 bit data bus display green data.	DB[7:0]	8 bit data bus display blue data.	
MCU Type	Function Description													
RGB interface	DR[7:0]			8 bit data bus display red data.										
	DG[7:0]			8 bit data bus display green data.										
	DB[7:0]	8 bit data bus display blue data.												
13-20	G0-G7													
21-28	B0-B7													
29	GND	P	Ground											
30	DOTCLK	I	Clock signal for data latching and internal counter of the timing controller.											
31	DISPLAY	-	Display on/off mode control.											
32	HSYNC	I	Horizontal sync input with negative polarity.											
33	VSYNC	I	Vertical sync input with negative polarity.											
34	DE	I	Input data enable control.											
35	GRB	I	Global reset pin. When GRB is "L", internal initialization procedure is executed											
36	ENPROG	I	OTP program control pin. <table border="1"> <thead> <tr> <th>ENPROG</th> <th>Function Description</th> </tr> </thead> <tbody> <tr> <td>L</td> <td>Disable OTP program function</td> </tr> <tr> <td>H</td> <td>Enable OTP program function</td> </tr> </tbody> </table>	ENPROG	Function Description	L	Disable OTP program function	H	Enable OTP program function					
ENPROG	Function Description													
L	Disable OTP program function													
H	Enable OTP program function													
37	SCL	I	Serial communication clock input.											
38	SDA	I	Serial communication data input and output.											
39	CS	I	Serial communication chip selection. CS is not used in I2C interface and should be connected to "H".											
40	GND	P	Ground											

PS. For further details, please refer to ST7262 data sheet.

4. Absolute Maximum Rating

AGND = GND = 0V , Ta = 25° C

Item	Symbol	Min	Max	Unit	Remark
Power Voltage	VCC	-0.3	4.0	V	
Operating Temperature	T _{OPR}	-20	70	° C	
Storage Temperature	T _{STG}	-30	80	° C	

The absolute maximum rating values of this product are not allowed to be exceeded at any times. Should a module be used with any of the absolute maximum ratings exceeded, the characteristics of the module may not be recovered, or in an extreme case, the module may be permanently destroyed.

5. Electrical Characteristics

5.1. Recommended Operating Condition

AGND = GND = 0V , Ta = 25° C

Item	Symbol	Min	Typ.	Max	Unit	Remark
Power Voltage	VCC	3.0	3.3	3.6	V	
Input logic high voltage	V _{IH}	0.7 VCC	-	VCC	V	
Input logic low voltage	V _{IL}	0	-	0.3VCC	V	

5.2. Recommended Driving Condition for Backlight

Ta = 25° C

Item	Symbol	Min	Typ.	Max	Unit	Remark
Forward Voltage	V _f		18		V	
Forward Current	I _f		120		mA	
Operating Life Time	-	36000			Hours	

Note 1: The LED supply voltage is defined by the number of LED at Ta=25°C and I_f=120mA.

Note 2: The “Operating Life Time” is defined as the module brightness decrease to 50% original brightness at Ta=25°C and I_f=120 mA. The LED lifetime could be decreased if operating I_f is larger than 120 mA.

6. Timing Characteristics

6.1. AC Electrical Characteristics

System Operation AC Characteristics

Item	Symbol	Min.	Typ.	Max.	Unit	Conditions
VDD Power Source Slew Time	TPOR	-	-	20	ms	From 0V to 99% VDD
GRB Pulse Width	tRSTW	10	50	-	us	R=10Kohm, C=1uF
SD Output Stable Time	Tst	-	-	TBD	us	Output settled within +20mV Loading = 6.8k+28.2pF.
GD Output Rise and Fall Time	Tgst	-	-	TBD	us	Output settled (5%~95%), Loading = 4.7k+29.8pF

6.2.DC Electrical Characteristics

DC Electrical Characteristics (PVDD=VDD=VDDI= 3.3V, AGND= 0V, TA=25°C, Bare Chip)

Recommended Operating Range

Item	Symbol	Min.	Typ.	Max.	Unit	Conditions
Supply Voltage	VDD	3.0	3.3	3.6	V	
IO Supply Voltage	VDDI	3.0	-	3.6	V	
Charge Pump Supply Voltage	PVDD	3.0	3.3	3.6	V	
OTP Supply Voltage	VPP	7.4	7.5	7.6	V	

DC Characteristics for Digital Circuit

Item	Symbol	Min.	Typ.	Max.	Unit	Conditions
Logic-High Input Voltage	Vih	0.7VDDI	-	VDDI	V	
Logic-Low Input Voltage	Vil	DGND	-	0.3VDDI	V	
Logic-High Output Voltage	Voh	VDDI-0.4	-	VDDI	V	
Logic-Low Output Voltage	Vol	DGND	-	DGND+0.4	V	

DC Characteristics for Analog Circuit

Item	Symbol	Min.	Typ.	Max.	Unit	Conditions
Positive High-Voltage Power	VGH	TBD	TBD	TBD	V	No Load@ FR=60Hz
Negative High-Voltage Power	VGL	TBD	TBD	TBD	V	
Output Voltage Deviation	Vod	-	TBD	TBD	mV	
Standby Current	Isc	-	TBD	-	uA	
Operation Current	Ioc	-	TBD	-	mA	

6.3.Timing

System Bus Timing for RGB Interface

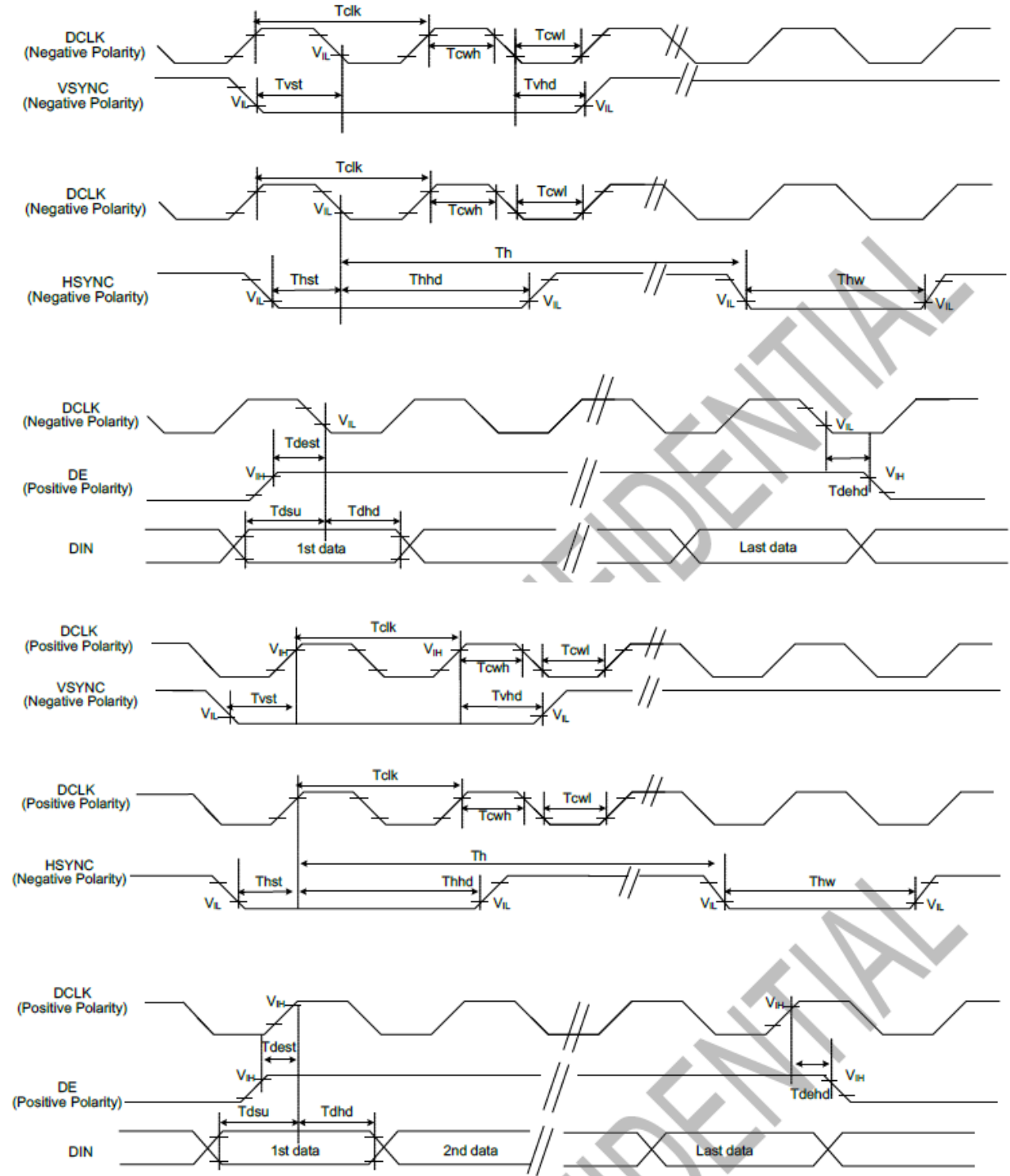

Item	Symbol	Min.	Typ.	Max.	Unit	Conditions
CLK Pulse Duty	Tcw	40	50	60	%	
HSYNC Width	Thw	2	-	-	DCLK	
HSYNC Period	Th	55	60	65	us	
VSYNC Setup Time	Tvst	12	-	-	ns	
VSYNC Hold Time	Tvhd	12	-	-	ns	
HSYNC Setup Time	Thst	12	-	-	ns	
HSYNC Hold Time	Thhd	12	-	-	ns	
Data Setup Time	Tdsu	12	-	-	ns	
Data Hold Time	Tdhd	12	-	-	ns	
DE Setup Time	Tdest	12	-	-	ns	
DE Hold Time	Tdehd	12	-	-	ns	

6.4. Power ON/OFF Sequence

Power On Sequence

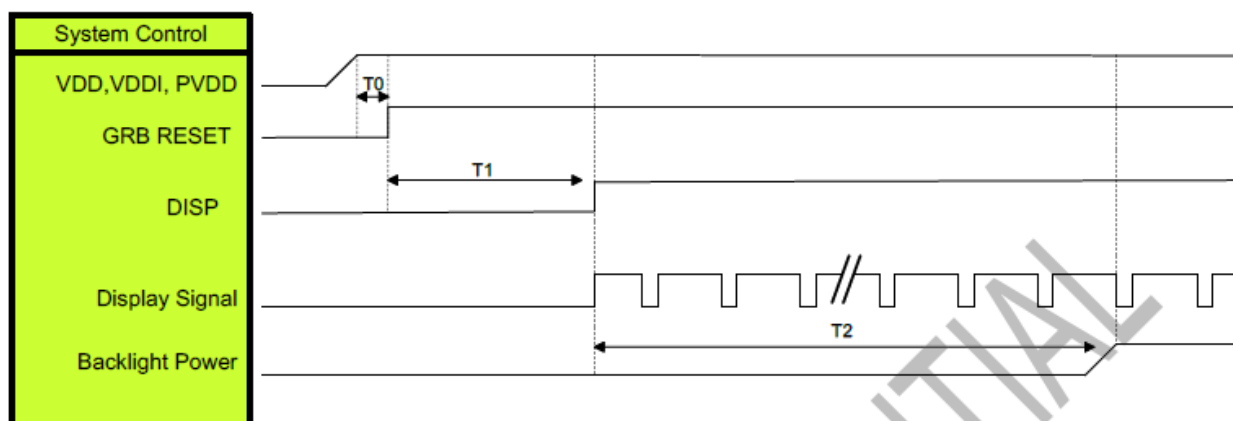

Symbol	Description	Min. Time	Unit
T0	System power stability to GRB RESET signal	0	ms
T1	GRB RESET="High" to DISP="High"	10	ms
T2	Display Signal output to Backlight Power on	250	ms

Note: RGB interface Display signal: DCLK; VSYNC; HSYNC; DE; DR[7:0]; DG[7:0]; DB[7:0]

Note: LVDS interface Display signal: DCLK P/N; RX[3:0]P/N

Power Off Sequence

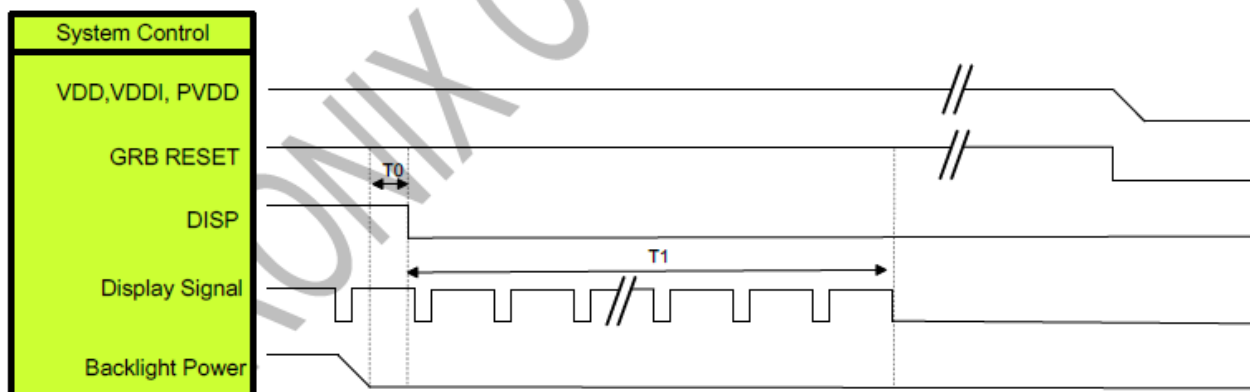

Symbol	Description	Min. Time	Unit
T0	Backlight Power off to DISP="Low"	5	ms
T1	DISP="Low" to IC internal voltage discharge complete	100	ms

Note: RGB interface Display signal: DCLK; VSYNC; HSYNC; DE; DR[7:0]; DG[7:0]; DB[7:0]

Note: LVDS interface Display signal: DCLK P/N; RX[3:0]P/N

7. Optical Characteristics

Item	Symbol	Condition	Min	Typ.	Max	Unit	Remark
View Angles	θT	$CR \geq 10$	70	80		Degree	Note 2
	θB		70	80			
	θL		70	80			
	θR		70	80			
Contrast Ratio	CR	$\theta = 0^\circ$	(1000)	(1500)			Note 1 Note 3
Response Time	T_{ON}	$25^\circ C$	-	30	40	ms	Note 1
	T_{OFF}						Note 4
Chromaticity	W_x	x	0.298	0.318	0.338		Note 1
	W_y	y	0.321	0.341	0.361		Note 5
Uniformity	U		75	80		%	Note 5
Luminance	L		800	1000		cd/m ²	Note 1 Note 5

Test Conditions:

1. $I_f=120mA$ (Backlight current), $VCC = 3.3 V$, the ambient temperature is $25^\circ C$.
2. The test systems refer to Note 2.

Note1: Definition of optical measurement system.

The optical characteristics should be measured in dark room. After 5Minutes operation, the optical properties are measured at the center point of the LCD screen. ALL input terminals LCD panel must be ground when measuring the center area of the panel.

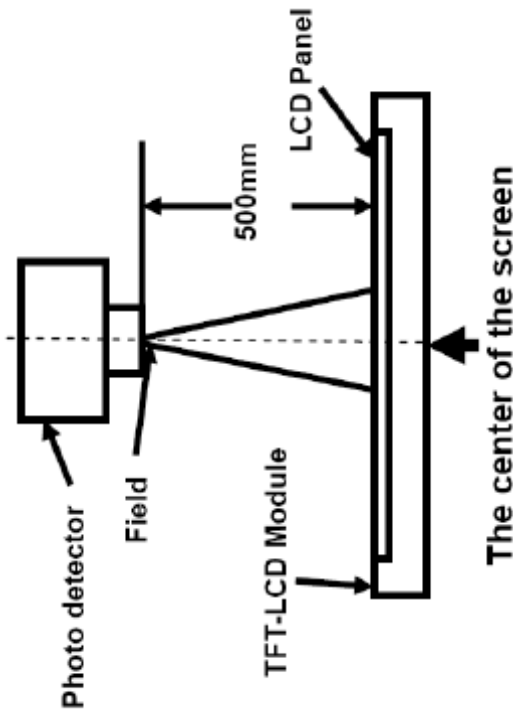

Item	Photo detector	Field
Contrast Ratio	CS1000	1°
Luminance		
Lum Uniformity		
Chromaticity	CS1000	
Response Time	DMS703	-

Note2: Definition of viewing angle range and measurement system.

Viewing angle is measured at the center point of the LCD by CONOSCOPE (DMS703)

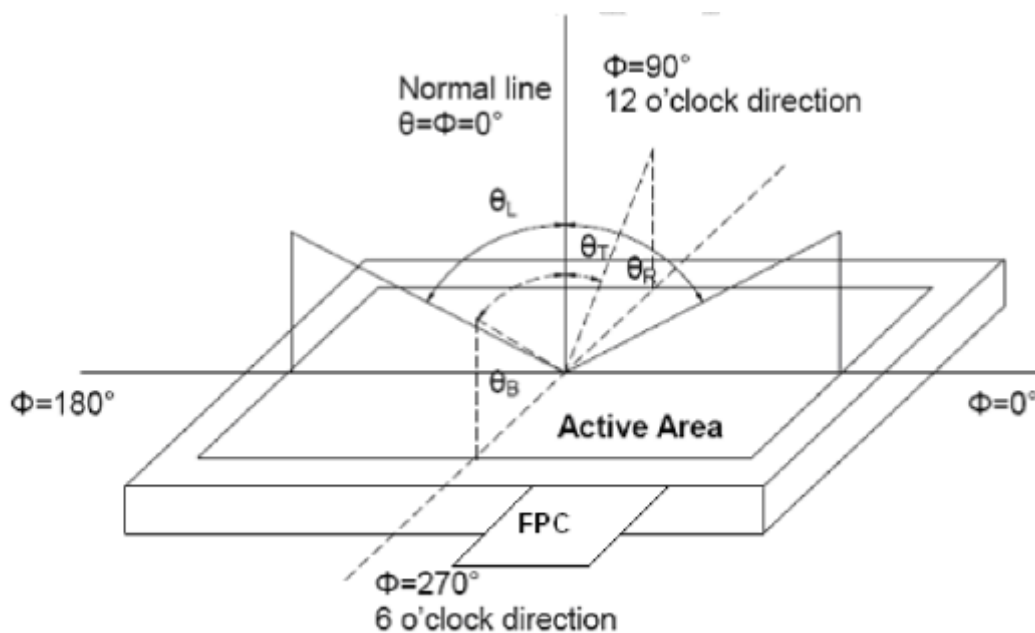

Note3: Definition of contrast ratio

$$\text{Contrast ratio (CR)} = \frac{\text{Luminance measured when LCD is on the "White" state}}{\text{Luminance measured when LCD is on the "Black" state}}$$

“White state ”:The state is that the LCD should drive by V_{white} .

“Black state ”:The state is that the LCD should drive by V_{black} .

V_{white} : To be determined V_{black} : To be determined

Note4:Definition of Response time

The response time is defined as the LCD optical switching time interval between “White”state and “Black” state. Rise time (T_{ON})is the time between photo detector output intensity changed from 90% to 10%.And fall time (T_{OFF})is the time between photo detector output intensity changed from 10% to90%.

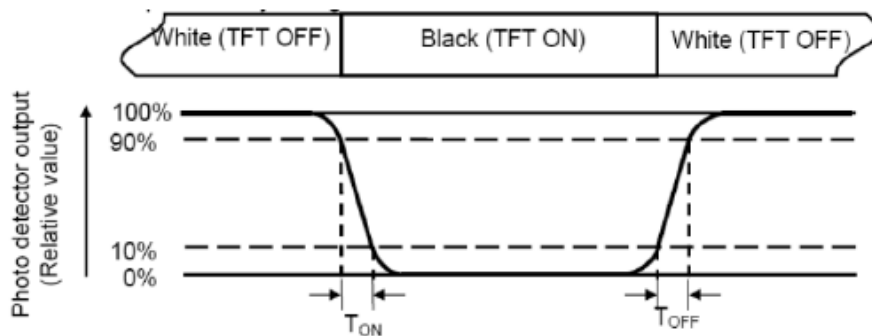

Note5:Definition of color chromaticity (CIE1931)

Color coordinates measured at center point of LCD.

Note6: Definition of Luminance Uniformity

Active area is divided into 9 measuring areas(Refer Fig.2).Every measuring point is placed at the center of each measuring area.

$$\text{Luminance Uniformity (U)} = L_{\text{min}} / L_{\text{max}}$$

L-----Active area length W-----Active area width

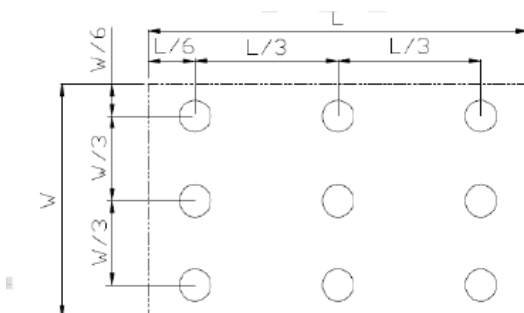

L_{max} : The measured Maximum luminance of all measurement position.

L_{min} : The measured Minimum luminance of all measurement position.

Note7: Definition of luminance: Measure the luminance of white state at center point.

8. Environmental/Reliability Test

No.	Test Item	Test Condition	Inspection after test
1	High Temperature Storage	80±2°C/240 hours	Inspection after 2~4hours storage at room temperature, the sample shall be free from defects: 1.Air bubble in the LCD; 2.Sealleak; 3.Non-display; 4.missing segments; 5.Glass crack; 6.Current Idd is twice higher than initial value.
2	Low Temperature Storage	-30±2°C/240 hours	
3	High Temperature Operating	70±2°C/240 hours	
4	Low Temperature Operating	-20±2°C/240 hours	
5	Temperature Cycle	-30°C~25°C~ 80°C × 10cycles (30min.) (5min.) (30min.)	
6	Damp Proof Test	40°C±5°C×90%RH/240 hours	
7	Vibration Test	Frequency: 10Hz~55Hz~10Hz Amplitude: 1.5mm, X, Y, Z direction for total 3hours (Packing condition)	
8	Dropping test	Drop to the ground from 1m height, one time, every side of carton. (Packing condition)	
9	ESD/2pcs	Voltage:±8KV R: 330Ω C: 150pF Air discharge, 10time	
		Voltage:±6KV R: 330Ω C: 150pF Contact discharge, 10time	

Remark:

- The test samples should be applied to only one test item.
- Sample size for each test item is 5~10pcs.
- For Damp Proof Test, Pure water(Resistance>10MΩ) should be used.
- In case of malfunction defect caused by ESD damage, if it would be recovered to normal state after resetting, it would be judge as a good part.
- Failure Judgment Criterion: Basic Specification, Electrical Characteristic, Mechanical Characteristic, Optical Characteristic.
- Please use automatic switch menu(or roll menu) testing mode when test operating mode.

9. Packing Drawing(TBD)

10. Standard Specifications For Product Quality

10.1. Manner of test:

10.1.1 The test must be under 40W fluorescent light, and the distance of view must be at 30±10cm.

10.1.2 Room temperature 25±5°C Humidity: (60±10)%RH.

10.2. Quality specification

It shall be based on GB2828-87, inspection level II .

	IETM	CHECK LEVEL	AQL
MAJOR (MA)	1.Liquid crystal leakage 2.Wrong polarizer 3.Outside dimension 4. Bright dot、 Dark dot 5. Display abnormal 6. Class crack	II	0.25
MINOR (MI)	1. Spot Defect (Including black spot、 white spot、 pinhole、 foreign particle、 bubbles、 hurt) 2. fragment 3. Line Defect (Including black line、 white line、 cratch) 4. Incision defect 5. Newton's ring 6. Other visual defects	II	1.0

10.3. Definition of area:

10.3.1 I area: viewing area

II area: outside viewing area

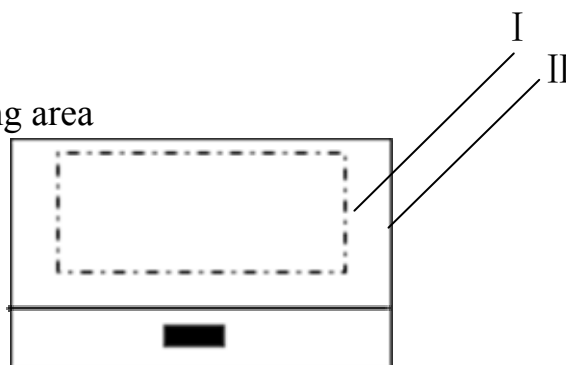

10.4. Standard of appearance test for I area: (unit: mm)

NOTE: Defect ignore for II area.

10.4.1 Bright/Dark Dots explain

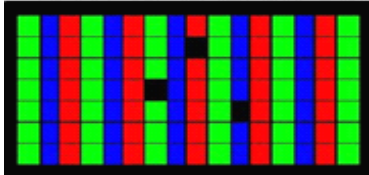
Name	Explain	Definition
Bright dot	Dots appear bright and unchanged in size in which LCD panel is displaying under black pattern 	The definition of dot: The size of a defective dot over 1/2 of single pixel dot is regarded as one defective dot . NOTE: One pixel consists of 3 sub-pixels, including R,G, and B dot.(Sub-pixel = Dot)
Dark dot	Dots appear dark and unchanged in size in which LCD panel is displaying under pure red, green, blue pattern. 	
ADJACENT DOT	Adjacent two sub-pixel are defect (define two dot defect)	

10.4.2 Inspection standard

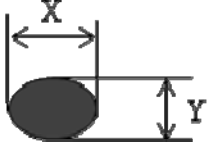
No	Items	Criterion		Checking Manner	Defect Classes
1	Bright/dark dot	Under 6" (contain 6")	Bright dot: 2 Dark dot: $N \leq 4$ Note: be more than 5mm apart	Checking with eyes	MAJ
		6"-12"	Bright dot: $N \leq 4$ Dark dot: $N \leq 5$ Total Bright and Dark Dots: $N \leq 8$ Note : 1.Two bright dot defects (red, green, blue, and white) should be larger than 15mm; 2.The distance between black dot defects or black and bright dot defects should be more than 5mm apart.		
2	Spot Defect (Including black spot.white spot. Pinhole.foreign particle.bubbles.hurt)  $D=(X+Y)/2$	Under 6" (contain 6")	$D \leq 0.1$ Ignore $0.1 < D \leq 0.35$ $N \leq 3$ $0.35 < D$ $N=0$	Checking with eyes	MIN
		6"-12"	$D \leq 0.3$ Ignore $0.3 < D \leq 0.6$ $N \leq 4$ $0.6 < D$ $N=0$		

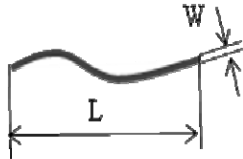
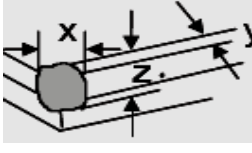
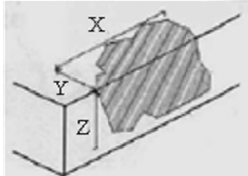
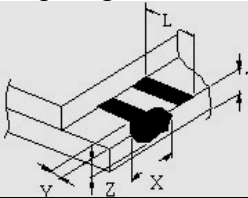
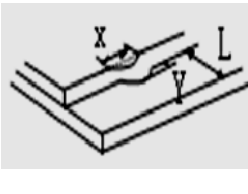
№	Items	Criterion		Checking manner	Defect classes
3	Line Defect (Including black Line.white line. scratch) 	Under 6" (contain 6")	$W \leq 0.02$ Ignore $0.02 < W \leq 0.04$ $L \leq 5$ $N \leq 2$ $0.04 < W \leq 0.06$ $L \leq 5$ $N \leq 1$ $W > 0.06$ $N = 0$	Checking with eyes	MIN
		6"-12"	$W \leq 0.07$ Ignore $0.07 < W \leq 0.1$ $L \leq 10$ $N \leq 4$ $W > 0.1$ $N = 0$		
4	Display abnormal	Not allowed		Checking with eyes	MAJ
5	Outside dimension	Accord with drawing		Callipers	MAJ
6	Class crack	Not allowed		Checking with eyes	MAJ
7	Leak	Not allowed		Checking with eyes	MAJ
8	Comer fragment 	$X \leq 3$ $Y \leq 3$ $Z \leq T$ Ignore Note : 1.No hurt identifying .wire.seal 2.T: Glass thickness X: Length Y: Width Z: thickness		Checking with eyes	MIN
9	Side fragment 	$Y \leq 1$ $Z \leq T$ Ignore Note : 1.No hurt identifying .wire.seal 2.T: Glass thickness X: Length Y: Width Z: thickness		Checking with eyes	MIN
	Step fragment 	$Y \leq 1$ and $Y \leq 1/4 L$		Checking with eyes	MIN
	Incision defect 	$Y \leq 1$ and accord with outside dimension		Checking with eyes	MIN

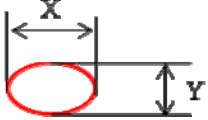
№	Items	Criterion		Checking manner	Defect classes
10	Newton's ring (CTP or Cover board)  $D=(X+Y)/2$	Under 6" (contain 6")	$D \leq 25$ $N \leq 3$ $D > 25$ $N = 0$	Checking with eyes	MIN
6"-12"	$D \leq 70$ $N \leq 5$ $D > 70$ $N = 0$				

11. Precautions for Use of LCD Modules

11.1 Handing Precautions

(1) The display panel is made of glass and polarizer. As glass is fragile. It tends to become or chipped during handling especially on the edges. Please avoid dropping or jarring. Do not subject it to a mechanical shock by dropping it or impact.

(2) If the display panel is damaged and the liquid crystal substance leaks out, be sure not to get any in your mouth. If the substance contacts your skin or clothes, wash it off using soap and water.

(3) Do not apply excessive force to the display surface or the adjoining areas since this may cause the color tone to vary. Do not touch the display with bare hands. This will stain the display area and degraded insulation between terminals (some cosmetics are determined to the polarizer).

(4) The polarizer covering the display surface of the LCD module is soft and easily scratched. Handle this polarizer carefully. Do not touch, push or rub the exposed polarizers with anything harder than an HB pencil lead (glass, tweezers, etc.). Do not put or attach anything on the display area to avoid leaving marks on. Condensation on the surface and contact with terminals due to cold will damage, stain or dirty the polarizer. After products are tested at low temperature they must be warmed up in a container before coming is contacting with room temperature air.

(5) If the display surface becomes contaminated, breathe on the surface and gently wipe it with a soft dry cloth. If it is heavily contaminated, moisten cloth with one of the following solvents

- Isopropyl alcohol
- Ethyl alcohol

Do not scrub hard to avoid damaging the display surface.

(6) Solvents other than those above-mentioned may damage the polarizer.

Especially, do not use the following.

- Water
- Ketone
- Aromatic solvents

Wipe off saliva or water drops immediately, contact with water over a long period of time may cause deformation or color fading. Avoid contacting oil and fats.

(7) Exercise care to minimize corrosion of the electrode. Corrosion of the electrodes is accelerated by water droplets, moisture condensation or a current flow in a high-humidity environment.

(8) Install the LCD Module by using the mounting holes. When mounting the LCD module make sure it is free of twisting, warping and distortion. In particular, do not forcibly pull or bend the IO cable or the backlight cable.

(9) Do not attempt to disassemble or process the LCD module.

(10) NC terminal should be open. Do not connect anything.

(11) If the logic circuit power is off, do not apply the input signals.

(12) Electro-Static Discharge Control, Since this module uses a CMOS LSI, the same careful attention should be paid to electrostatic discharge as for an ordinary

CMOS IC. To prevent destruction of the elements by static electricity, be careful to maintain an optimum work environment.

- Before remove LCM from its packing case or incorporating it into a set, be sure the module and your body have the same electric potential. Be sure to ground the body when handling the LCD modules.

- Tools required for assembling, such as soldering irons, must be properly grounded. make certain the AC power source for the soldering iron does not leak. When using an electric screwdriver to attach LCM, the screwdriver should be of ground potentiality to minimize as much as possible any transmission of electromagnetic waves produced sparks coming from the commutator of the motor.

- To reduce the amount of static electricity generated, do not conduct assembling and other work under dry conditions. To reduce the generation of static electricity be careful that the air in the work is not too dried. A relative humidity of 50%-60% is recommended. As far as possible make the electric potential of your work clothes and that of the work bench the ground potential.

The LCD module is coated with a film to protect the display surface. Exercise care when peeling off this protective film since static electricity may be generated.

(13) Since LCM has been assembled and adjusted with a high degree of precision, avoid applying excessive shocks to the module or making any alterations or modifications to it.

- Do not alter, modify or change the shape of the tab on the metal frame.
- Do not make extra holes on the printed circuit board, modify its shape or change the positions of components to be attached.
- Do not damage or modify the pattern writing on the printed circuit board.
- Absolutely do not modify the zebra rubber strip (conductive rubber) or heat seal connector.
- Except for soldering the interface, do not make any alterations or modifications with a soldering iron.
- Do not drop, bend or twist LCM.

11.2 Storage Precautions

When storing the LCD modules, the following precaution is necessary.

(1) Store them in a sealed polyethylene bag. If properly sealed, there is no need for the dessicant.

(2) Store them in a dark place. Do not expose to sunlight or fluorescent light, keep the temperature between 0°C and 35°C.

(3) The polarizer surface should not come in contact with any other objects. (We advise you to store them in the container in which they were shipped).

11.3 Others

Liquid crystals solidify under low temperature (below the storage temperature range) leading to defective orientation or the generation of air bubbles (black or white). Air bubbles may also be generated if the module is subject to a low temperature.

If the LCD modules have been operating for a long time showing the same display patterns, the display patterns may remain on the screen as ghost images and a slight contrast irregularity may also appear. A normal operating status can be regained by suspending use for some time. It should be noted that this

phenomenon does not adversely affect performance reliability.

To minimize the performance degradation of the LCD modules resulting from destruction caused by static electricity etc., exercise care to avoid holding the following sections when handling the modules.

- Exposed area of the printed circuit board.
- Terminal electrode sections.

11.4 USING LCD MODULES

Installing LCD Modules

The hole in the printed circuit board is used to fix LCM as shown in the picture below. Attend to the following items when installing the LCM.

(1) Cover the surface with a transparent protective plate to protect the polarizer and LC cell.

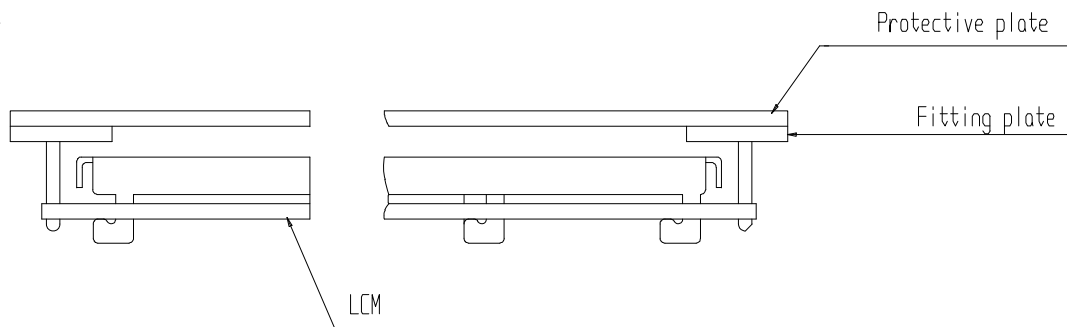

(2) When assembling the LCM into other equipment, the spacer to the bit between the LCM and the fitting plate should have enough height to avoid causing stress to the module surface, refer to the individual specifications for measurements. The measurement tolerance should be $\pm 0.1\text{mm}$.

Precaution for assemble the module with BTB connector:

Please note the position of the male and female connector position, don't assemble or assemble like the method which the following picture shows

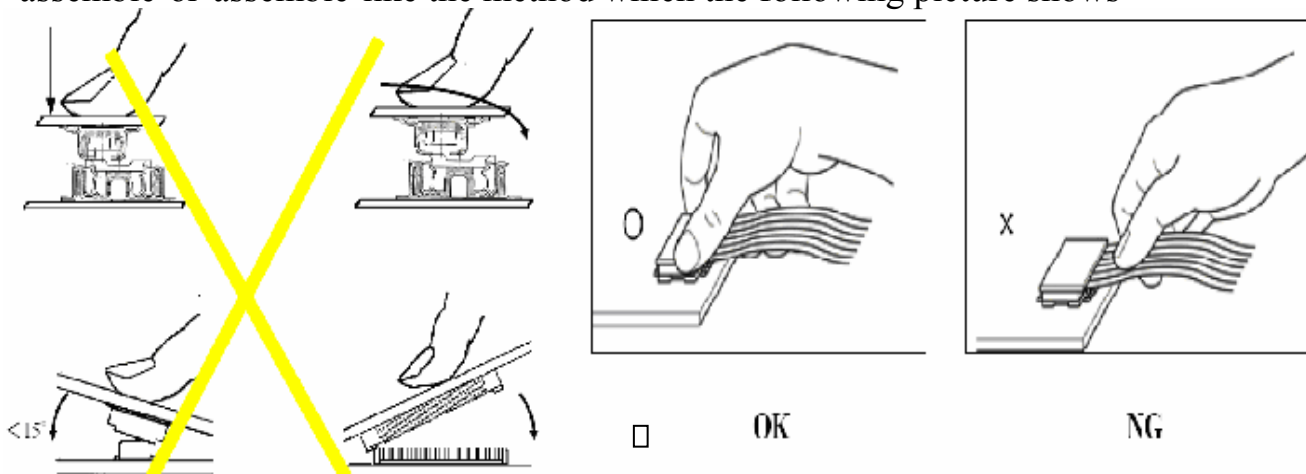

Precaution for soldering to the LCM

	Hand soldering	Machine drag	Machine press soldering
No ROHS Product	290°C~350°C. Time : 3-5S.	330°C ~350°C. Speed : 4-8mm/s.	300°C~330C. Time : 3-6S. Press: 0.8~1.2Mpa

ROHS Product	340°C~370°C. Time : 3-5S.	350°C ~370°C. Time : 4-8 mm/s.	330°C~360C. Time : 3-6S. Press: 0.8~1.2Mpa
--------------	------------------------------	-----------------------------------	--

(1) If soldering flux is used, be sure to remove any remaining flux after finishing to soldering operation. (This does not apply in the case of a non-halogen type of flux.) It is recommended that you protect the LCD surface with a cover during soldering to prevent any damage due to flux spatters.

(2) When soldering the electroluminescent panel and PC board, the panel and board should not be detached more than three times. This maximum number is determined by the temperature and time conditions mentioned above, though there may be some variance depending on the temperature of the soldering iron.

(3) When remove the electroluminescent panel from the PC board, be sure the solder has completely melted, the soldered pad on the PC board could be damaged.

Precautions for Operation

(1) It is an indispensable condition to drive LCD's within the specified voltage limit since the higher voltage then the limit cause the shorter LCD life. An electrochemical reaction due to direct current causes LCD's undesirable deterioration, so that the use of direct current drive should be avoided.

(2) Response time will be extremely delayed at lower temperature than the operating temperature range and on the other hand at higher temperature LCD's show dark color in them. However those phenomena do not mean malfunction or out of order with LCD's, Which will come back in the specified operating temperature.

(3) If the display area is pushed hard during operation, the display will become abnormal. However, it will return to normal if it is turned off and then back on.

(4) A slight dew depositing on terminals is a cause for electro-chemical reaction resulting in terminal open circuit. Usage under the maximum operating temperature, 50%RH or less is required.

(5) Input each signal after the positive/negative voltage becomes stable.

(6) Please keep the temperature within specified range for use and storage.

Polarization degradation, bubble generation or polarizer peel-off may occur with high temperature and high humidity.

Safety

(1) It is recommended to crush damaged or unnecessary LCDs into pieces and wash them off with solvents such as acetone and ethanol, which should later be burned.

(2) If any liquid leaks out of a damaged glass cell and comes in contact with the hands, wash off thoroughly with soap and water.

11.5 The disposal of waste

For waste disposal, our recommendations are as follows, please refer to your company and the relevant provisions of the state laws and regulations of the act accordingly

1. Packing materials disposal for our packaging (carton/PS tray/EPE tray/PET tray)
 - 1) Our company used to recycle and reuse materials, packing materials can be you just need to transfer to material recycling companies
 2. Our scrap module can't be recycled for reuse, so please dispose of,
 - 1) Our scrap module can't be recycled for reuse, products and components are "served" can lead to accidents
 - 2) Our scrap can be transfer to material recycling companies, dismantling, to ensure that scrap in relatively advanced technology products, environmental protection measures of relatively perfect environment for processing.
 3. WEEE order must be executed in product scrap.

12. Prior Consult Matter

- 1.①For YES standard products, we keep the right to change material, process ... for improving the product property without notice on our customer.
 - ②For OEM products, if any change needed which may affect the product property, we will consult with our customer in advance.
- 2.If you have special requirement about reliability condition, please let us know before you start the test on our samples.

13. Factory

FACTORY NAME: YES OPTOELECTRONICS CO.,LTD

FACTORY ADDRESS: No.288Yueling Road Anshan, Liaoning, P.R.CHINA

FACTORY PHONE: 86-412-5211859 FAX: 86-412-5211729